



OUTDOOR KITCHEN

CATALOGO GENERALE // GENERAL CATALOG

2024





Scopri la linea **outdoor kitchen** su lisaoutdoor.com
Discover the **outdoor kitchen** line on lisaoutdoor.com



LEGENDA / LEGEND

USO INTERNO / INDOOR USE



USO ESTERNO PROTETTO / PROTECTED OUTDOOR USE



4	Da 20 anni la qualità al primo posto // <i>Since 20 years, quality in first place</i>
6	L'outdoor kitchen, da sogno a realtà // <i>Outdoor kitchen, from dream to reality</i>
8	Cucine nate forti e gentili // <i>Kitchen born "strong and gentle"</i>
10	Perché scegliere LISA // <i>Why choose Lisa</i>
12	Moduli singoli, Linea Okinawa e Isole // <i>Single units, Okinawa line and Islands</i>
14	Moduli Singoli // <i>Single units</i>
16	Giglio - Giudecca
17	Murano - Burano
18	Linea Okinawa // <i>Okinawa line</i>
20	Okinawa 60
21	Okinawa 120 Sportelli - Okinawa 120 Cassetti
22	Okinawa 150 Sportelli e Cassetti
23	Okinawa 150 Sportelli - Okinawa 150 Cassetti - Okinawa 150 Kamado JOE
24	Okinawa 180 Sportelli - Okinawa 180 Sportelli e Cassetti - Okinawa 180 XXL
26	Isole // <i>Islands</i>
28	Panarea - Capri
30	Capri BBQ Kamado Sportelli - Capri BBQ Kamado Sportelli e Cassetti - Isole con Tip-on
32	Linea Liberty // <i>Liberty line</i>
34	Liberty Green - Liberty Steel - Modelli compatibili // <i>Compatible Models</i>
36	Outdoor kitchen personalizzate // <i>Customized Outdoor Kitchen</i>
38	Come personalizzare la tua cucina // <i>How to customize your Kitchen</i>
40	Linea Elba // <i>Elba Line</i>
42	Moduli 45 cm // <i>17 6/8 in units</i>
43	Moduli 60 cm // <i>23 3/5 in units</i>
44	Moduli 90 cm // <i>35 1/2 in units</i>
45	Moduli 120 cm // <i>47 1/4 in units</i>
46	Linea Pantelleria // <i>Pantelleria Line</i>
48	Moduli 45 cm // <i>17 6/8 in units</i>
49	Moduli 60 cm // <i>23 3/5 in units</i>
50	Moduli 90 cm // <i>35 1/2 in units</i>
51	Moduli 120 cm // <i>47 1/4 in units</i>
52	Linea Liberty // <i>Liberty line</i>
54	Moduli 45 cm // <i>17 6/8 in units</i> - Moduli 60 cm // <i>23 3/5 in units</i>
55	Moduli 90 - 100 - 120 cm // <i>35 1/2 - 39 3/8 - 47 1/4 in units</i>
56	Accessori // <i>Accessories</i>
58	Lavelli saldati & Miscelatori // <i>Welded sink & Mixer taps</i>
59	Miscelatori abbattibili, Barbecue a gas & Finiture // <i>Hidden mixer tap, Gas barbecue & Finishes</i>
60	Piani cottura stand alone // <i>Stand alone hobs</i>
61	Piedi, Sgabello & Top // <i>Feet, Stool & Tops</i>
62	Note // <i>Notes</i>

DA 20 ANNI LA QUALITÀ AL PRIMO POSTO

Presente dal **2004** nel mercato della trasformazione dell'acciaio con le migliori tecnologie, arricchite dal know-how acquisito con la realizzazione di arredamenti per marchi prestigiosi.

Da sempre attenta al design e alla funzionalità dei prodotti, attraverso la ricerca di linee moderne e la cura dei particolari.

La sua mission aziendale è offrire ai clienti un elevato livello qualitativo dei prodotti, nel rispetto di un target di prezzo. Questo grazie ad un investimento costante e continuo su tecnologie sempre aggiornate, ad un team di collaboratori di riconosciuta professionalità, competenza ed esperienza.

Dal 2020 il ciclo produttivo è completamente alimentato da energia pulita.

SINCE 20 YEARS, QUALITY IN FIRST PLACE

*Active since **2004** in the steel transformation market with the best technologies, enriched by the know-how acquired through the production of furnishings for prestigious brands. Always focussed on the design and functionality of its products, through the search for modern lines and attention to details.*

Its mission is to offer customers a high level product quality, respecting a price target. This is thanks to a constant and continuous investment in up-to-date technologies and to a team of collaborators of recognised professionalism, competence and experience.

Since 2020 the production cycle has been completely powered by clean energy.





L' OUTDOOR KITCHEN, DA SOGNO A REALTÀ

La vision aziendale è offrire una soluzione compatibile con gli spazi a disposizione e che soddisfi le necessità richieste dalla zona outdoor.

I prodotti a catalogo, rigorosamente Made in Italy, contraddistinti dalla cura dei dettagli e dalla scelta di componenti di prima qualità, si suddividono in tre categorie: moduli singoli, isole personalizzate e outdoor kitchen personalizzate. I moduli singoli sono prodotti indirizzati a coloro che cercano una soluzione compatta e dinamica, un concentrato di qualità su ruote posizionabile in 64cm di spazio.

Le isole outdoor sono prodotti di circa 180 cm, con un lavello e un piano cottura, indirizzati a coloro che hanno bisogno di una soluzione pronta all'uso, qualitativamente elevata e sviluppata per impreziosire la propria area outdoor living.

Nella categoria outdoor kitchen personalizzate rientrano un insieme di prodotti modulari che permettono di sviluppare da zero la cucina outdoor su misura, dipingendola nella propria zona outdoor, come un pittore su una tela bianca.

OUTDOOR KITCHEN, FROM DREAM TO REALITY

The company vision is to offer a solution that is compatible with the available space and fulfils the needs of the outdoor area.

The products in the catalogue, rigorously made in Italy, characterised by attention to detail and the choice of top quality components, are divided into three categories: single modules, customized islands and customized outdoor kitchens. The single units are products aimed at those seeking a compact and dynamic solution, a concentrate of quality on wheels that can be positioned in 64 cm of space.

The outdoor islands are products of approximately 180 cm, with a sink and hob, addressed to those who need a ready-to-use, high quality solution developed to embellish their outdoor living area.

The customized outdoor kitchen category includes a set of modular products that allow you to develop your own customized outdoor kitchen from scratch, painting it into your outdoor area, like a painter on a blank canvas.







CUCINE NATE FORTI E GENTILI

I nostri prodotti nascono circondati dalla bellezza.

Nascono protetti dalla forza degli appennini abruzzesi e accarezzati con gentilezza dalle onde della costa adriatica.

È da qui, dal nostro stabilimento di Pescara, che il design delle nostre produzioni viene contaminato dalle caratteristiche del nostro territorio. La forza e la stabilità delle strutture in acciaio, rifinite nei minimi particolari abbracciano la gentilezza delle linee, la dolcezza delle chiusure e l'armonia dei dettagli.

Un risultato finale che trasmette l'amore per la propria terra, l'attenzione nel proprio lavoro richiamando alla memoria la bellezza delle lavorazioni artigianali proprie del Made in Italy nella sua accezione originale del termine.





KITCHEN BORN “STRONG AND GENTLE”

Our products are born surrounded by beauty.

They are born protected by the strength of the Abruzzo Apennines and gently caressed by the waves of the Adriatic coast.

And it is from here, from our factory in Pescara, that the design of our products is contaminated by the characteristics of our land. The strength and stability of the steel structures, finished to the smallest detail, embrace the gentleness of the lines, the softness of the closures and the harmony of the details.

An end result that conveys the love for one's land, the care in one's work, recalling the beauty of craftsmanship typical of Made in Italy in its original meaning of the term.



PERCHÉ SCEGLIERE LISA

I moduli singoli, le isole outdoor e le cucine personalizzate presentano, nella loro composizione, alcuni dettagli importanti che contribuiscono a elevarne la qualità e l'estetica.

Una delle caratteristiche che accomuna tutti i prodotti della Lisa è la presenza di guide e di cerniere della Hettich, marchio leader nella produzione di sistemi di chiusura per ante e cassetti di qualità elevata.

Tutte le guide e cerniere della Hettich scelte sono dotate di sistema di ammortizzazione e grazie alla qualità indiscussa delle guide, i cassetti raggiungono la portata di 40kg.

Tutte le cucine sono rifinite internamente anche nelle ante e nei cassetti.

Realizzate in acciaio inox 304, su richiesta disponibile anche in acciaio inox 316L.

WHY CHOOSE LISA

The single units, the outdoor islands and the customized kitchens have some important features in their composition that contribute to enhancing their quality and aesthetics.

One of this, which all Lisa's products have in common, is the use of guides and hinges by Hettich, a leading brand in the production of high-quality door and drawer closing systems.

All chosen Hettich guides and hinges are equipped with the damping system, and thanks to the undisputed quality of the guides, the drawers reach a load capacity of 40kg.

All kitchens are also internally finished in the doors and drawers.

Made of 304 stainless steel top, available on request also 316L stainless steel top.



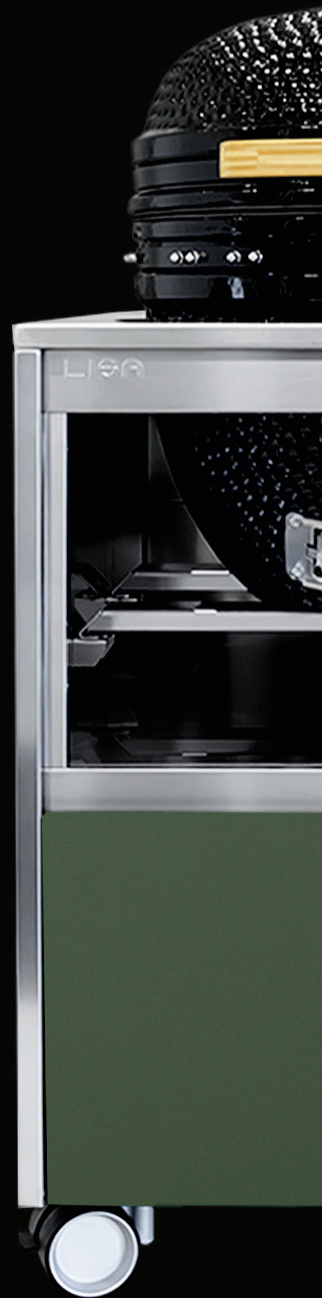



MODULI SINGOLI, LINEA OKINAWA E ISOLE //
SINGLE UNITS, OKINAWA LINE AND ISLANDS



MODULI SINGOLI, LINEA OKINAWA E ISOLE // SINGLE UNITS, OKINAWA LINE AND ISLANDS

MODULI SINGOLI



Componenti d'arredo pronti a soddisfare ogni esigenza.

I moduli hanno fianchi e top slim che, insieme alle ante con gola, conferiscono carattere ed eleganza. Disponibili in varie configurazioni, facilmente collocabili e adatti ad ogni tipo di richiesta. Dotati di ruote per facilitarne lo spostamento.

Furniture components ready to meet every need.

The modules have slim sides and tops which, together with the doors with grooves, lend character and elegance.

Available in various configurations, they are easy to place and suitable for every requirement.

Equipped with wheels for easy movement.

Colori disponibili per tutte le versioni // Available colors for all versions



ACCIAIO //
BRUSHED STAINLESS
STEEL

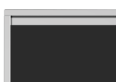

ANTRACITE //
ANTHRACITE
RAL 9004

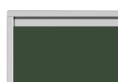

VERDE //
GREEN
RAL 6003



BIANCO //
WHITE
RAL 9001





COD OUT001 - GIGLIO

- Modulo da 64 x 70 cm in acciaio inox 304 scotch brite con un'anta.
- Top alto 2 cm in acciaio inox 304.
- Sistema di apertura con Gola.
- Anta con sistema di ammortizzazione.
- Quattro ruote piroettanti di cui due frontali con freno.
- Disponibile in tre configurazioni.

- *25 1/4 x 27 1/2 in module in 304 scotch brite stainless steel with one door.*
- *4/5 inches high 304 stainless steel top.*
- *Opening system with recessed grip profile.*
- *Door with damping system.*
- *Four swivel castors, two of which at the front with brakes.*
- *Available in three configurations.*



COD OUT002 - GIUDECCA

- Modulo da 64 x 70 cm in acciaio inox 304 scotch brite con due cassettoni.
- Top alto 2 cm in acciaio inox 304.
- Sistema di apertura con Gola.
- Cassettoni di 357 mm di altezza con sistema di ammortizzazione della portata di 40 kg.
- Quattro ruote piroettanti di cui due frontali con freno.
- Disponibile in due configurazioni.

- *25 1/4 x 27 1/2 in module in 304 scotch brite stainless steel with two drawers.*
- *4/5 inches high 304 stainless steel top.*
- *Opening system with recessed grip profile.*
- *14 inches high deep drawers with 40 kg capacity with damping system.*
- *Four swivel castors, two of which are front wheels with brakes.*
- *Available in two configurations.*



COD OUT003 - MURANO



- Modulo da 64 x 70 cm in acciaio inox 304 scotch brite con due cassetti, un cassettone e top alto 2 cm in acciaio inox 304.
- Sistema di apertura con Gola.
- Cassettone di 357mm di altezza e 40 kg di portata e cassetti di 177mm di altezza e 40 kg di portata con sistema di ammortizzazione.
- Quattro ruote piroettanti di cui due frontali con freno.
- Disponibile in due configurazioni.

- 25 1/4 x 27 1/2 in module in 304 scotch brite stainless steel with two drawers and one deep drawer
- 4/5 inches high 304 stainless steel top.
- Opening system with recessed grip profile.
- 14 inches high deep drawer and 40 kg capacity and 7 inches high drawers with 40 kg capacity with damping system.
- Four swivel castors, two of which are front wheels with brakes.
- Available in two configurations.

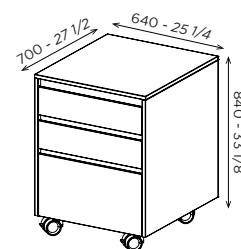

COD OUT004 - BURANO

- Modulo da 64 x 70 cm in acciaio inox 304 scotch brite con quattro cassetti e top alto 2 cm in acciaio inox 304.
- Sistema di apertura con Gola.
- Cassetti di 177mm di altezza con sistema di ammortizzazione con portata di 40 kg.
- Quattro ruote piroettanti di cui due frontali con freno.
- Disponibile in due configurazioni.

- 25 1/4 x 27 1/2 in module in 304 scotch brite stainless steel with four drawers.
- 4/5 inches high 304 stainless steel top.
- Opening system with recessed grip profile.
- 7 inches high drawers with 40 kg capacity with damping system.
- Four swivel castors, two of which are front wheels with brakes.
- Available in two configurations.

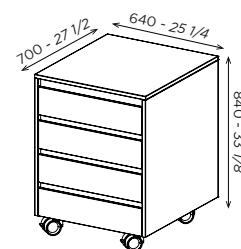



LINEA OKINAWA

La linea Okinawa prende nome dall'omonima isola del Giappone.

Tutti i modelli della linea sono nati per integrare e sorreggere barbecue della tipologia Kamado, tipico barbecue a carbone di origini nipponiche.

Nella linea sono disponibili otto modelli, dal modulo singolo di 64 cm di larghezza all'isola di 184 cm.

The Okinawa line takes its name from the homonymous island in Japan.

All the models in the line were created to integrate and support Kamado type barbecues, a typical charcoal barbecue of Japanese origins.

Eight models are available in the line, from the single 25,20 inches wide module to the 72,44 inches island.

Fori disponibili // Available holes



Mensola regolabile in altezza // Support shelf adjustable

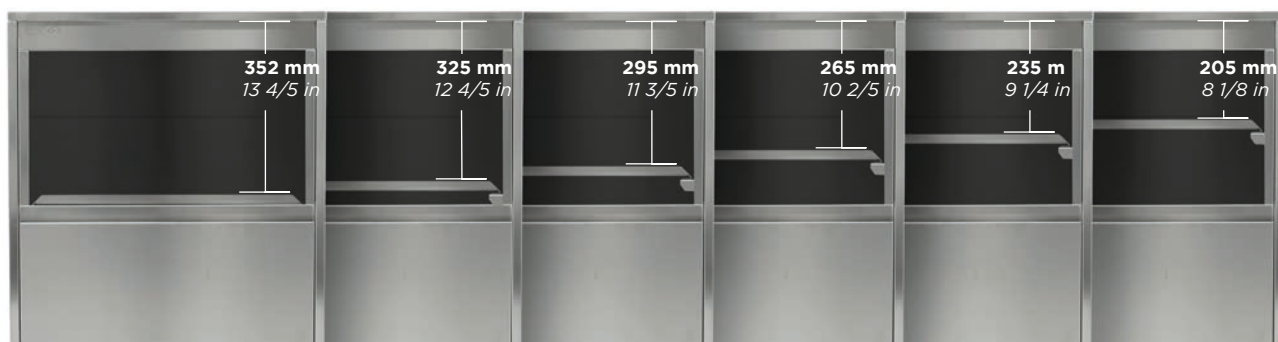

Colori disponibili // Available colors



ACCIAIO // BRUSHED STAINLESS STEEL

ANTRACITE // ANTHRACITE RAL 9004

VERDE // GREEN RAL 6003

BIANCO // WHITE RAL 9001





COD OUT013 - OKINAWA 60

- Modulo da 64 x 70 cm in acciaio inox 304 scotch brite con un cassettone.
- Top alto 2 cm in acciaio inox 304.
- Sistema di apertura con Gola.
- Cassettone di 357 mm di altezza con sistema di ammortizzazione della portata di 40 kg.
- Foro per inserimento Kamado disponibile in quattro diametri diversi.
- Mensola di appoggio Kamado regolabile in cinque altezze diverse.
- Quattro ruote piroettanti di cui due frontali con freno.

- 25 1/4 x 27 1/2 inches module in 304 scotch brite stainless steel with one deep drawer
- 4/5 inches high 304 stainless steel top.
- Opening system with recessed grip profile.
- Drawer 14 inches high and 40 kg capacity with damping system.
- Hole for Kamado insertion available in four different diameters.
- Kamado support shelf adjustable to five different heights.
- Four swivel castors, two of which are front wheels with brakes.

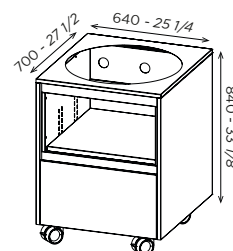
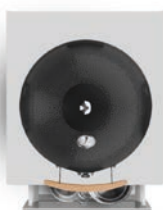



COD OUT014_S - OKINAWA 120 SPORTELLO

- Modulo da 124 x 70 cm in acciaio inox 304 scotch brite.
- Top alto 2 cm in acciaio inox 304.
- Sistema di apertura con Gola.
- Un cassettone e un'anta con sistema di ammortizzazione.
- Foro per inserimento Kamado disponibile in quattro diametri diversi.
- Mensola di appoggio Kamado regolabile in cinque altezze diverse.
- Sei ruote piroettanti di cui due frontali con freno.

- 48 7/8 x 27 1/2 inches module in 304 scotch brite stainless steel.
- 4/5 inches high 304 stainless steel top.
- Opening system with recessed grip profile.
- A deep drawer and a door with damping system.
- Hole for Kamado insertion available in four different diameters.
- Kamado support shelf adjustable to five different heights.
- Six swivel castors, two of which are front wheels with brakes.

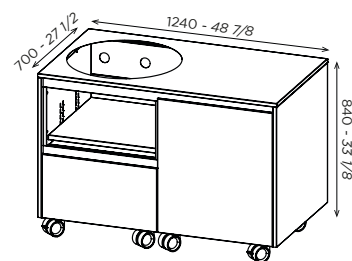

COD OUT014_C - OKINAWA 120 CASSETTI

- Modulo da 124 x 70 cm in acciaio inox 304 scotch brite.
- Top alto 2 cm in acciaio inox 304.
- Sistema di apertura con Gola.
- Due cassettoni e due cassette con sistema di ammortizzazione.
- Foro per inserimento Kamado disponibile in quattro diametri diversi.
- Mensola di appoggio Kamado regolabile in cinque altezze diverse.
- Sei ruote piroettanti di cui due frontali con freno.

- 48 7/8 x 27 1/2 inches module in 304 scotch brite stainless steel.
- 4/5 inches high 304 stainless steel top.
- Opening system with recessed grip profile.
- Two deep drawers and two drawers with damping system.
- Hole for Kamado insertion available in four different diameters.
- Kamado support shelf adjustable to five different heights.
- Six swivel castors, two of which are front wheels with brakes.

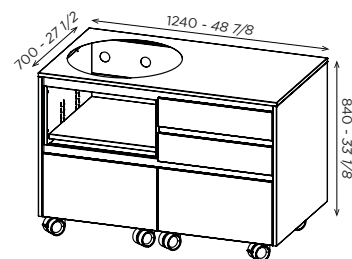



COD OUT015_CS - OKINAWA 150 SPORTELLI E CASSETTI

- Modulo da 154 x 70 cm in acciaio inox 304 scotch brite.
- Top alto 2 cm in acciaio inox 304.
- Sistema di apertura con Gola.
- Un cassettone, due cassetti e due ante con sistema di ammortizzazione.
- Foro per inserimento Kamado disponibile in quattro diametri diversi.
- Mensola di appoggio Kamado regolabile in cinque altezze diverse.
- Otto ruote piroettanti di cui due frontali con freno.

- *60 3/5 x 27 1/2 inches module in 304 scotch brite stainless steel.*
- *4/5 inches high 304 stainless steel top.*
- *Opening system with recessed grip profile.*
- *A deep drawer, two drawers and two doors with damping system.*
- *Hole for Kamado insertion available in four different diameters.*
- *Kamado support shelf adjustable to five different heights.*
- *Eight swivel castors, two of which are front wheels with brakes.*

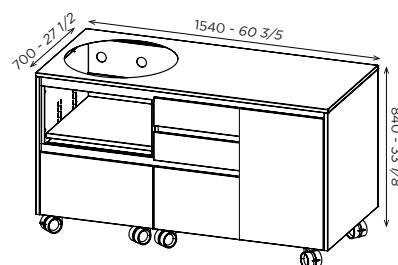
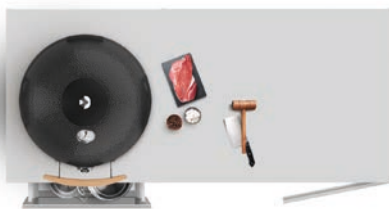

COD OUT015_S - OKINAWA 150 SPORTELLI

- Modulo da 154 x 70 cm in acciaio inox 304 scotch brite.
- Top alto 2 cm in acciaio inox 304.
- Sistema di apertura con Gola.
- Un cassettone e due ante con sistema di ammortizzazione.
- Foro per inserimento Kamado disponibile in quattro diametri diversi.
- Mensola di appoggio Kamado regolabile in cinque altezze diverse.
- Otto ruote piroettanti di cui due frontali con freno.

- *60 3/5 x 27 1/2 inches module in 304 scotch brite stainless steel.*
- *4/5 inches high 304 stainless steel top.*
- *Opening system with recessed grip profile.*
- *A deep drawer and two doors with damping system.*
- *Hole for Kamado insertion available in four different diameters.*
- *Kamado support shelf adjustable to five different heights.*
- *Eight swivel castors, two of which are front wheels with brakes.*

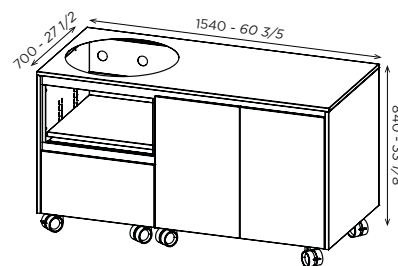
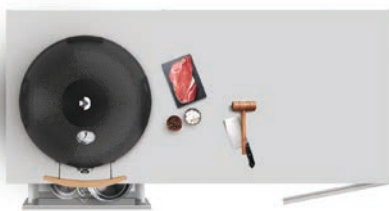



COD OUT015_C - OKINAWA 150 CASSETTI

- Modulo da 154 x 70 cm in acciaio inox 304 scotch brite.
- Top alto 2 cm in acciaio inox 304.
- Sistema di apertura con Gola.
- Due cassettoni e due cassetti con sistema di ammortizzazione.
- Foro per inserimento Kamado disponibile in quattro diametri diversi.
- Mensola di appoggio Kamado regolabile in cinque altezze diverse.
- Otto ruote piroettanti di cui due frontali con freno.

- 60 3/5 x 27 1/2 inches module in 304 scotch brite stainless steel.
- 4/5 inches high 304 stainless steel top.
- Opening system with recessed grip profile.
- Two deep drawers and two drawers with damping system.
- Hole for Kamado insertion available in four different diameters.
- Kamado support shelf adjustable to five different heights.
- Eight swivel castors, two of which are front wheels with brakes.

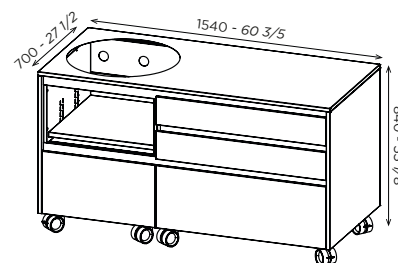

COD OUT016_KJ - OKINAWA 150 KAMADO JOE

Compatibile con Kamado JOE Classic II e Classic III

- Modulo da 154 x 70 cm in acciaio inox 304 scotch brite.
- Top alto 2 cm in acciaio inox 304.
- Sistema di apertura con Gola.
- Un cassettone, due cassetti e due ante con sistema di ammortizzazione.
- Otto ruote piroettanti di cui due frontali con freno.

Compatible with Kamado JOE Classic II e Classic III

- 60 3/5 x 27 1/2 inches module in 304 scotch brite stainless steel.
- 4/5 inches high 304 stainless steel top.
- Opening system with recessed grip profile.
- A deep drawer, two drawers and two doors with damping system.
- Eight swivel castors, two of which are front wheels with brakes.

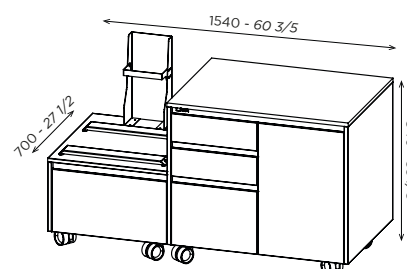



COD OUT016_S - OKINAWA 180 SPORTELLI

- Modulo da 184 x 70 cm in acciaio inox 304 scotch brite.
- Top alto 2 cm in acciaio inox 304.
- Sistema di apertura con Gola.
- Un cassettono e due ante con sistema di ammortizzazione.
- Foro per inserimento Kamado disponibile in quattro diametri diversi.
- Mensola di appoggio Kamado regolabile in cinque altezze diverse.
- Otto ruote piroettanti di cui due frontali con freno.

- *72 1/2 x 27 1/2 inches module in 304 scotch brite stainless steel.*
- *4/5 inches high 304 stainless steel top.*
- *Opening system with recessed grip profile.*
- *A deep drawer and two doors with damping system.*
- *Hole for Kamado insertion available in four different diameters.*
- *Kamado support shelf adjustable to five different heights.*
- *Eight swivel castors, two of which are front wheels with brakes.*

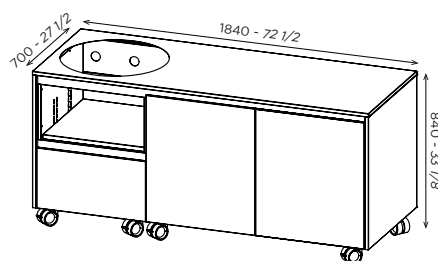

COD OUT016_CS - OKINAWA 180 SPORTELLI E CASSETTI

- Modulo da 184 x 70 cm in acciaio inox 304 scotch brite.
- Top alto 2 cm in acciaio inox 304.
- Sistema di apertura con Gola.
- Due cassettoni, due cassetti e un'anta con sistema di ammortizzazione.
- Foro per inserimento Kamado disponibile in quattro diametri diversi.
- Mensola di appoggio Kamado regolabile in cinque altezze diverse.
- Otto ruote piroettanti di cui due frontali con freno.

- *72 1/2 x 27 1/2 inches module in 304 scotch brite stainless steel.*
- *4/5 inches high 304 stainless steel top.*
- *Opening system with recessed grip profile.*
- *Two deep drawers, two drawers and a door with damping system.*
- *Hole for Kamado insertion available in four different diameters.*
- *Kamado support shelf adjustable to five different heights.*
- *Eight swivel castors, two of which are front wheels with brakes.*

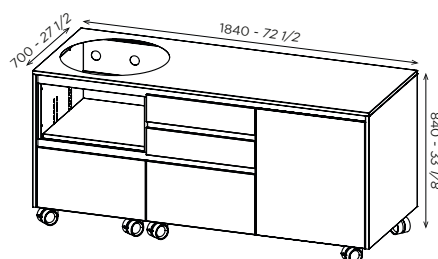



COD OUT017_CSR - OKINAWA 180 XXL

- Modulo da 184 x 100 cm in acciaio inox 304 scotch brite.
- Top alto 2 cm in acciaio inox 304.
- Sistema di apertura con Gola.
- Quattro cassetti e un'anta con sistema di ammortizzazione.
- Foro per inserimento Kamado disponibile in quattro diametri diversi.
- Mensola di appoggio Kamado regolabile in cinque altezze diverse.
- Otto ruote piroettanti di cui due frontali con freno.
- Appendieria laterale.

- *72 1/2 x 39 3/8 inches module in 304 scotch brite stainless steel.*
- *4/5 inches high 304 stainless steel top.*
- *Opening system with recessed grip profile.*
- *Four drawers and a door with damping system.*
- *Hole for Kamado insertion available in four different diameters.*
- *Kamado support shelf adjustable to five different heights.*
- *Eight swivel castors, two of which are front wheels with brakes.*
- *Side hanging rail.*

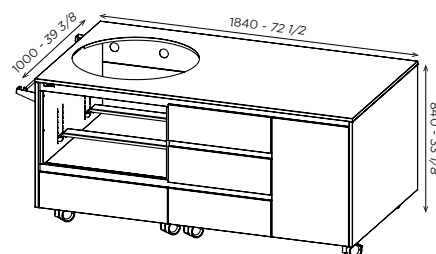



ISOLE // ISLANDS

ISOLE



Nelle isole outdoor si aggiunge alla versione con ante a gola, una soluzione dal design minimalista senza maniglie.

E' possibile scegliere tra una configurazione con top e fianchi slim e una con fianco strong e top con snack.

Una proposta compatta dotata di un lavello e un piano cottura domino.

Dotata di sei ruote per facilitarne lo spostamento. Disponibile in quattro versioni.

In addition to the version with groove doors, the outdoor islands offer a minimalist design solution without handles.

It is possible to choose between a configuration with slim top and sides and one with strong side and top with snack.

A compact proposal equipped with a sink and a domino hob. Equipped with six wheels for easy movement.

Available in four versions.

Colori disponibili per tutte le versioni // Available colors for all versions



ACCIAIO //
BRUSHED STAINLESS
STEEL

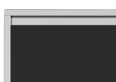

ANTRACITE //
ANTHRACITE
RAL 9004

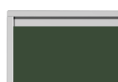

VERDE //
GREEN
RAL 6003



BIANCO //
WHITE
RAL 9001





COD OUT005 - PANAREA

- Isola da 188 x 100 cm in acciaio inox 304 scotch brite.
- Top con snack alto 4 cm in acciaio inox 304.
- Lavello saldato a filo top.
- Sistema di apertura con Gola.
- Quattro cassetti da 177 mm di altezza e portata 40 kg, due cassettoni da 357 mm e portata 40 kg e un'anta.
- Cassetti e sportello con sistema di ammortizzazione.
- Sei ruote piroettanti di cui due con freno.
- Disponibile in tre configurazioni.

- 74 x 39 3/8 inches island in stainless steel 304 scotch brite.
- Top with 1 1/2 inches high snacks in 304 stainless steel.
- Flush welded sink top.
- Opening system with recessed grip profile.
- Four 7 inches high drawers with 40 kg capacity, two 14 inches high deep drawers with 40 kg capacity and one door.
- Drawers and door with damping system.
- Six swivel castors, two with brakes.
- Available in three configurations.

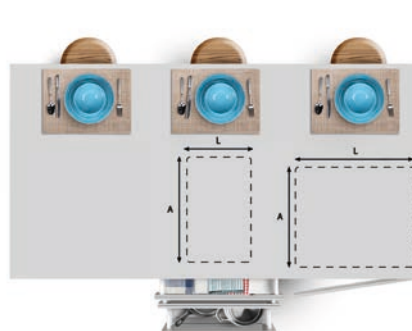
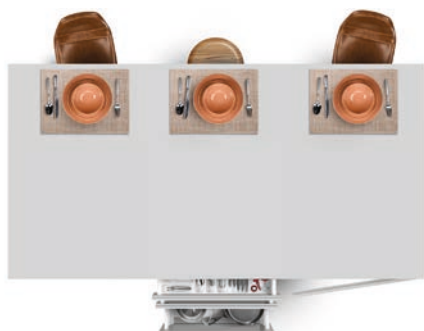
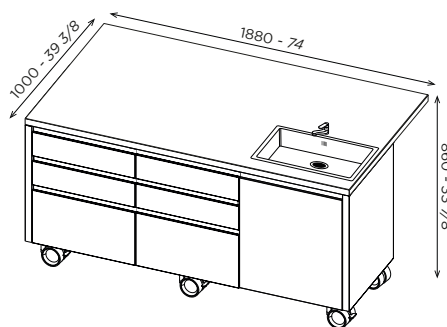

COD OUT005LS
PANAREA SOLO LAVELLO //
PANAREA WITH SINK ONLY

COD OUT005PN
PANAREA PIANO //
PANAREA WORKTOP

COD OUT005PR
PANAREA PERSONALIZZABILE //
CUSTOMIZABLE PANAREA





COD OUT007 - CAPRI

- Isola da 184 x 70 cm in acciaio inox 304 scotch brite.
- Top alto 2 cm in acciaio inox 304.
- Lavello saldato a filo top.
- Sistema di apertura con Gola.
- Quattro cassetti da 177 mm di altezza e portata 40 kg, due cassettoni da 357 mm e portata 40 kg e un'anta.
- Cassetti e sportello con sistema di ammortizzazione.
- Sei ruote piroettanti di cui due con freno.
- Disponibile in tre configurazioni.

- 72 1/2 x 27 1/2 inches island in stainless steel 304 scotch brite.
- Top with 4/5 inches high snacks in 304 stainless steel.
- Flush welded sink top.
- Opening system with recessed grip profile.
- Four 7 inches high drawers with 40 kg capacity, two 14 inches high deep drawers with 40 kg capacity and one door.
- Drawers and door with damping system.
- Six swivel castors, two with brakes.
- Available in three configurations.

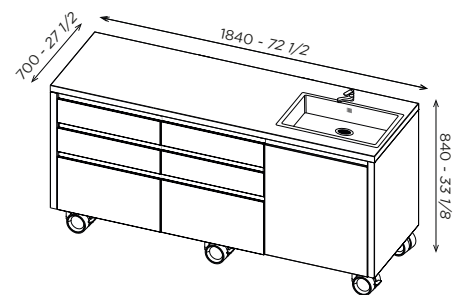

COD OUT007LS
CAPRI SOLO LAVELLO //
CAPRI WITH SINK ONLY

COD OUT007PN
CAPRI PIANO //
CAPRI WORKTOP

COD OUT007PR
CAPRI PERSONALIZZABILE //
CUSTOMIZABLE CAPRI





COD OUT007BK_S - CAPRI BBQ KAMADO SPORTELLI

- Modulo da 184 x 70 cm in acciaio inox 304 scotch brite.
 - Top alto 2 cm in acciaio inox 304.
 - Sistema di apertura con Gola.
 - Un cassettone e due ante con sistema di ammortizzazione e livello in acciaio saldato.
 - Foro per inserimento Kamado disponibile in quattro diametri diversi.
 - Mensola di appoggio Kamado regolabile in cinque altezze diverse.
 - Otto ruote piroettanti di cui due frontali con freno.
- *72 1/2 x 27 1/2 inches module in 304 scotch brite stainless steel.*
 - *4/5 inches high 304 stainless steel top.*
 - *Opening system with recessed grip profile.*
 - *A deep drawer and two doors with damping system and stainless steel welded sink.*
 - *Hole for Kamado insertion available in four different diameters.*
 - *Kamado support shelf adjustable to five different heights.*
 - *Eight swivel castors, two of which are front wheels with brakes.*

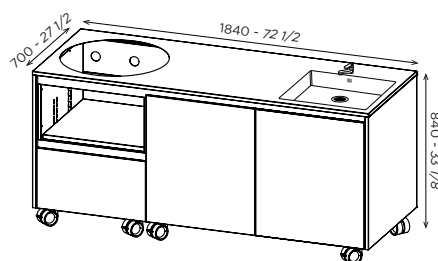

COD OUT007BK_CS - CAPRI BBQ KAMADO SPORTELLI E CASSETTI

- Modulo da 184 x 70 cm in acciaio inox 304 scotch brite.
 - Top alto 2 cm in acciaio inox 304.
 - Sistema di apertura con Gola.
 - Un cassettone, due cassetti e due ante con sistema di ammortizzazione e livello in acciaio saldato.
 - Foro per inserimento Kamado disponibile in quattro diametri diversi.
 - Mensola di appoggio Kamado regolabile in cinque altezze diverse.
 - Otto ruote piroettanti di cui due frontali con freno.
- *72 1/2 x 27 1/2 inches module in 304 scotch brite stainless steel.*
 - *4/5 inches high 304 stainless steel top.*
 - *Opening system with recessed grip profile.*
 - *A deep drawer, two drawers and two doors with damping system and stainless steel welded sink.*
 - *Hole for Kamado insertion available in four different diameters.*
 - *Kamado support shelf adjustable to five different heights.*
 - *Eight swivel castors, two of which are front wheels with brakes.*

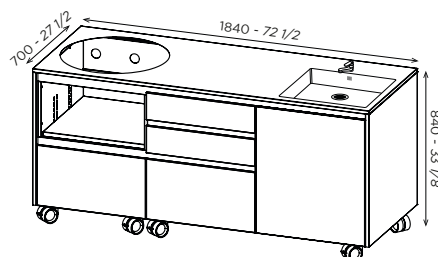

ISOLE DISPONIBILI CON SISTEMA TIP-ON //
AVAILABLE ISLANDS WITH TIP-ON SYSTEM



COD OUT006 - LIPARI



COD OUT008 - ISCHIA



COD OUT008BK_S - ISCHIA BBQ KAMADO
SPORTELLI



COD OUT008BK_CS - ISCHIA BBQ KAMADO
SPORTELLI E CASSETTI

PANNELLO FINITURA POSTERIORE // *BACK FINISHING PANEL*



CUCINA SENZA PANNELLO FINITURA POSTERIORE
KITCHEN WITHOUT BACK FINISHING PANEL



CUCINA CON PANNELLO FINITURA POSTERIORE
KITCHEN WITH BACK FINISHING PANEL



NAPOLEON

LEGEND

LION

LINEA LIBERTY // LIBERTY LINE

LINEA LIBERTY



La nuova cucina da esterno Lisa Liberty è un'opera di design e funzionalità, progettata per arricchire le tue esperienze culinarie all'aperto.

Realizzata in acciaio inox di alta qualità, questa cucina incarna l'eleganza e la durabilità. Uno dei suoi tratti distintivi è la gola che divide il cassetto dallo sportello, conferendo un tocco di stile contemporaneo.

The new Lisa Liberty outdoor kitchen is a work of design and functionality, designed to enrich your outdoor dining experiences.

Made of high-quality stainless steel, this kitchen embodies elegance and durability. One of its distinctive features is the recessed grip profile that divides the drawer from the door, giving a touch of contemporary style.

Colori disponibili per tutte le versioni // Available colors for all versions



ACCIAIO //
BRUSHED STAINLESS
STEEL

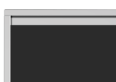

ANTRACITE //
ANTHRACITE
RAL 9004

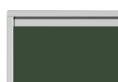

VERDE //
GREEN
RAL 6003



BIANCO //
WHITE
RAL 9001





COD OUT021_V - LIBERTY GREEN

- Modulo da 194 x 70 cm in acciaio inox 304 scotch brite.
 - Top alto 2 cm in acciaio inox 304.
 - Sistema di apertura con Gola.
 - Due cassetti e quattro ante con sistema di ammortizzazione.
 - Disponibile su piedi o su ruote.
- *76 2/5 x 27 1/2 inches module in 304 scotch brite stainless steel.*
 - *4/5 inches high 304 stainless steel top.*
 - *Opening system with recessed grip profile.*
 - *Two drawers and four doors with damping system.*
 - *Available on feet or on swivel castors.*

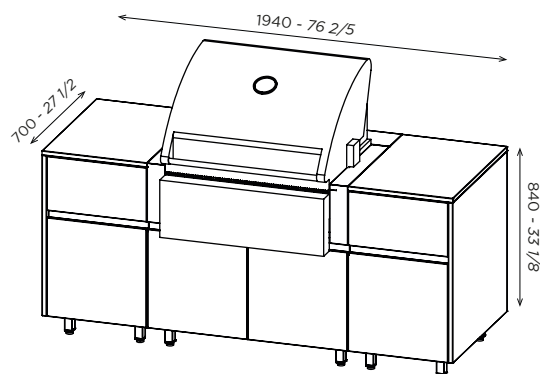

COD OUT022 - LIBERTY STEEL

- Modulo da 199 x 70 cm in acciaio inox 304 scotch brite.
 - Top alto 2 cm in acciaio inox 304.
 - Sistema di apertura con Gola.
 - Un cassetto e quattro ante con sistema di ammortizzazione.
 - Disponibile su piedi o su ruote.
- *78 3/8 x 27 1/2 inches module in 304 scotch brite stainless steel.*
 - *4/5 inches high 304 stainless steel top.*
 - *Opening system with recessed grip profile.*
 - *A drawer and four doors with damping system.*
 - *Available on feet or on swivel castors.*

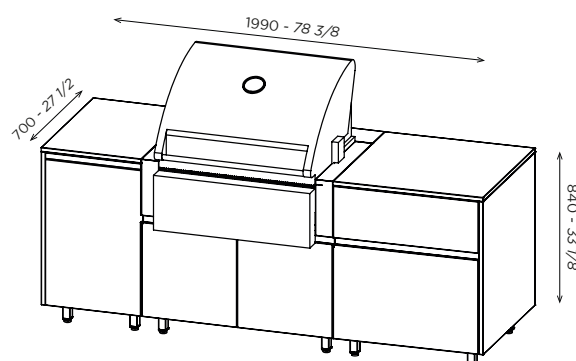

MODELLI ATTUALMENTE COMPATIBILI // CURRENTLY COMPATIBLE MODELS



BI32 - NAPOLEON



BIG38 - NAPOLEON



BIG44 - NAPOLEON



BILD485 - NAPOLEON



BILEX605 - NAPOLEON



BIPRO500 - NAPOLEON

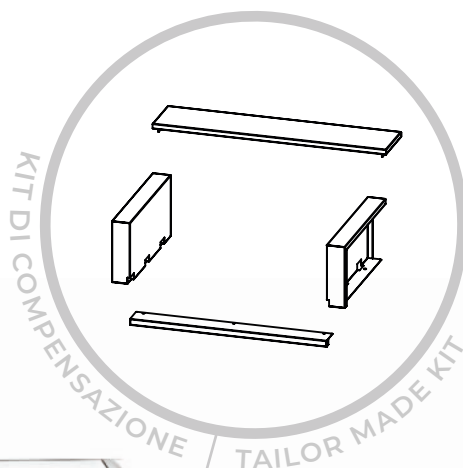

Grazie a una serie di kit di compensazione, sulla stessa base è possibile incassare diversi modelli di barbecue.

Ci sono diverse opzioni di personalizzazione disponibili grazie alla varietà di colori tra cui scegliere, permettendoti di adattare la cucina Liberty al tuo stile e all'ambiente circostante.

Thanks to tailor made adjustments kits, it is possible to insert different barbecue models on the same base.

There are several customization options available thanks to the variety of colors to choose from, allowing you to adapt the Liberty kitchen to your style and surrounding environment.



OUTDOOR KITCHEN PERSONALIZZATE //
CUSTOMIZED OUTDOOR KITCHEN



Con gola o minimale. Con animo fine o con una natura forte. Le scelte che doneranno carattere alla cucina personalizzata partiranno da una idea e, grazie all'aiuto dei nostri designer e al ventaglio di offerte del nostro catalogo, permetteranno di trovare una soluzione cucita sulle esigenze del cliente.

Sviluppiamo il progetto da zero, curandone ogni dettaglio, per arrivare ad una soluzione finale unica.

With recessed grip profile or minimal. With a fine spirit or with a strong nature. The choices that will give character to the customized kitchen will start with an idea and, with the assistance of our designers and the range of offerings in our catalogue, will lead to a solution tailored to the customer's needs.

We develop the project from scratch, taking care of every detail to arrive at a unique final solution.

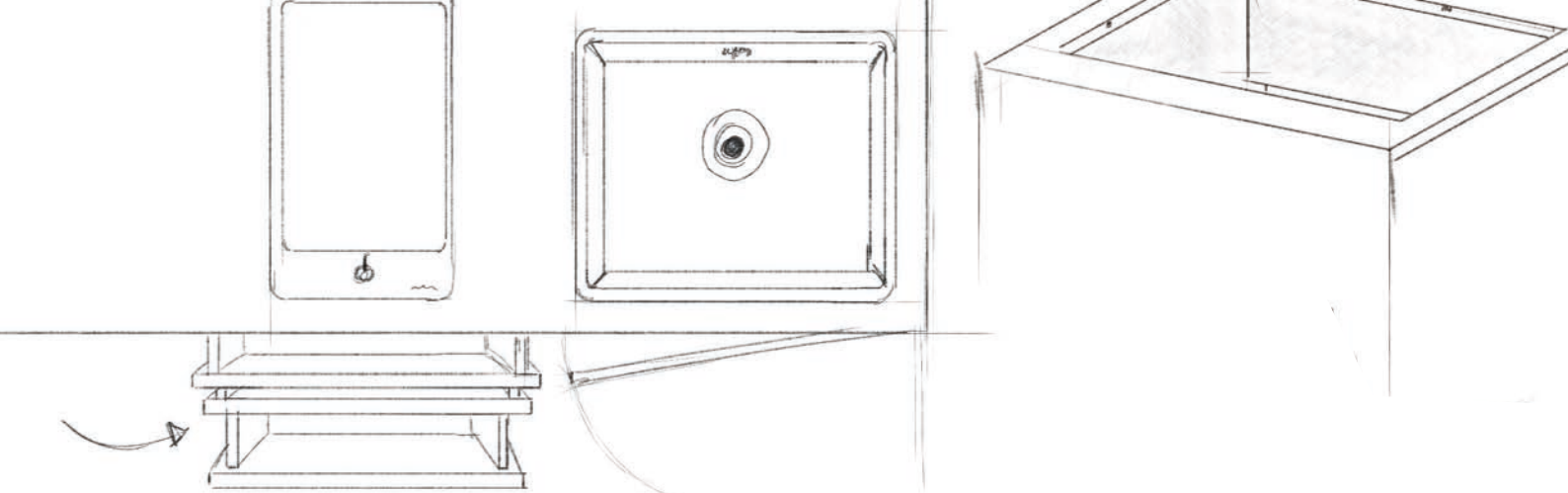

COME PERSONALIZZARE LA TUA CUCINA

SCELTA DELLA LINEA (1)

Il primo step per creare la tua cucina outdoor su misura è scegliere la linea che esteticamente e concettualmente ti piace di più.

Le linee disponibili sono **ELBA** e **PANTELLERIA**.

La linea **ELBA** è caratterizzata dal comodo sistema di apertura con gola. Questo sistema dona linearità al frontale della cucina senza perdere la funzionalità di una comoda maniglia. Tutte le ante e i cassetti sono equipaggiati con sistema di ammortizzazione che elimina il rischio di urto anche a seguito delle sollecitazioni più intense.

HOW TO CUSTOMIZE YOUR KITCHEN

LINE SELECTION (1)

*The first step in creating your custom-made outdoor kitchen is to choose the line that aesthetically and conceptually you like the most. The available lines are **ELBA** and **PANTELLERIA**.*

*The **ELBA** line is characterised by the handy opening system with recessed grip profile. This system gives linearity to the kitchen front without losing the functionality of a convenient handle. All doors and drawers are equipped with the damping system that eliminates the risk of knocks even under the most intense stress.*



La linea **PANTELLERIA** ha un design minimale grazie agli sportelli con sistema di apertura tip-on (spingi & apri). Il sistema permette, effettuando una leggera pressione sull'anta o sul cassetto chiuso, che lo sportello si apra automaticamente in modo fluido. Per chiudere basta spingere l'anta, o il cassetto, e questo si chiude dolcemente, grazie al sistema di ammortizzazione integrato.

*The **PANTELLERIA** line has a minimalist design with doors featuring a tip-on opening system (push & open). The system allows the door to open automatically and smoothly with a slight pressure on the closed door or drawer. To close, simply push the door, or drawer, and it closes smoothly, thanks to the integrated damping system.*



TOP E FIANCHI (2 & 3)

Dopo aver selezionato la linea e i moduli che ne compongono il corpo si passa alla scelta del top e dei fianchi.

E' possibile donare alla propria cucina un carattere più forte scegliendo il top e i fianchi **strong da 4 cm** oppure un'estetica più fine selezionando la tipologia **slim da 2cm**. E' selezionabile, inoltre, per la propria cucina un **top con estensione snack** di 30 cm e profondità totale di 100 cm.

ACCESSORI (4,5 & 6)

E' possibile scegliere se posizionare la propria cucina su **piedi** o su **ruote piroettanti**. Quest'ultima opzione aumenta la mobilità del prodotto e ne facilita lo spostamento all'interno della zona outdoor coperta.

La scelta degli **elettrodomestici** e del **lavello** con i suoi complementi è una parte importante del processo di personalizzazione della cucina outdoor.

Grazie al giusto elettrodomestico e alla presenza o meno del lavello, la cucina può diventare un componente fondamentale per vivere a pieno gli ambienti esterni dell'abitazione.

TOPS AND SIDES (2 & 3)

After selecting the line and the modules that make up its body, we move on to the choice of the top and sides.

It is possible to give your kitchen a stronger character by choosing the **1 1/2 inches strong** top and sides or a more refined look by selecting the **4/5 inches slim** type.

It is also possible to select a top with a **11 7/8 inches snack extension** and a total depth of **39 3/8 inches** for your kitchen.

ACCESSORIES (4,5 & 6)

You can choose whether to place your kitchen on **feet** or on **swivel castors**. The latter option increases the mobility of the product and facilitates its movement within the covered outdoor area.

The choice of **appliances** and **sink** with its accessories is an important part of the process of customizing your outdoor kitchen.

With the right appliance and the presence or absence of a sink, the kitchen can become a key component in fully experiencing the outdoors of the home.

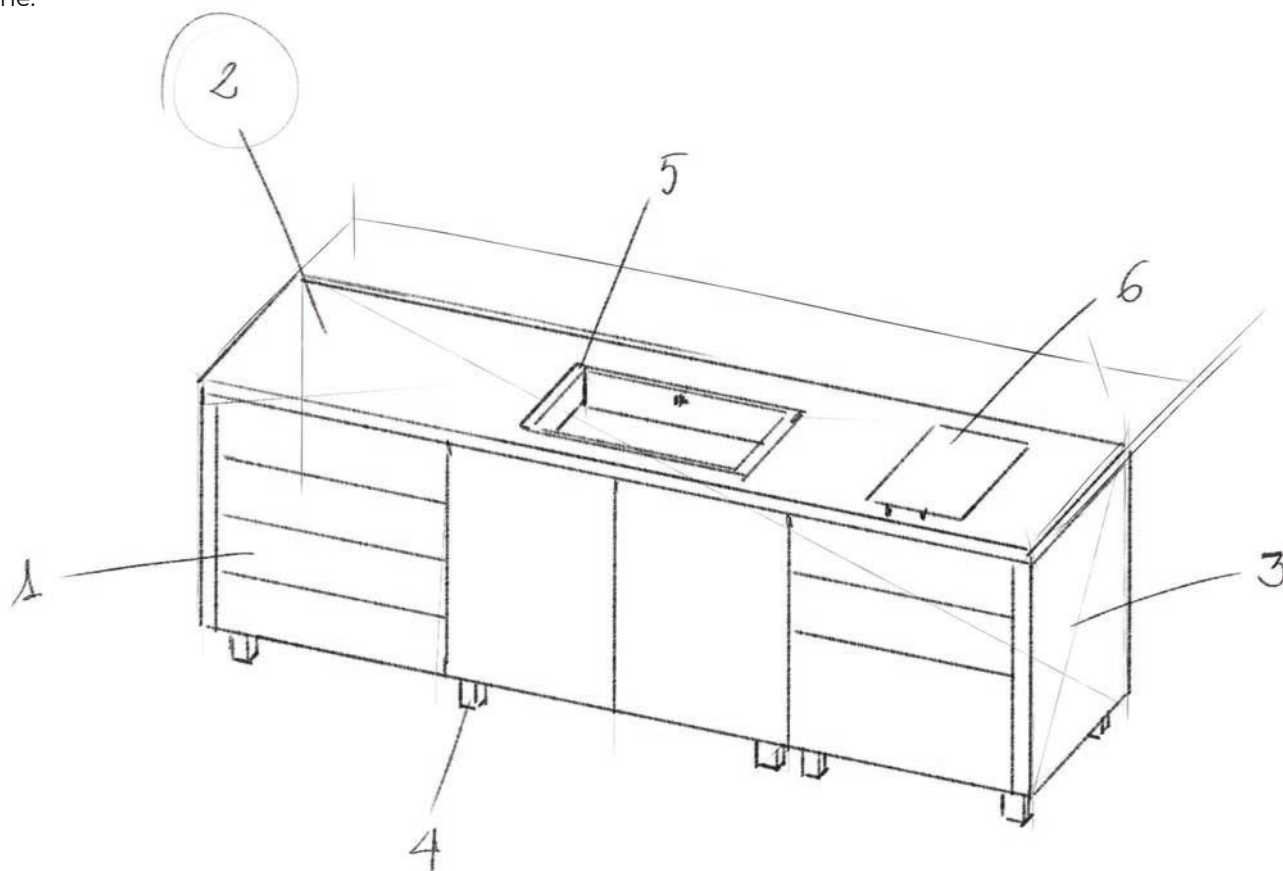





LINEA ELBA

BASI CON GOLA 45 - 60 - 90 - 120 cm

17 6/8 - 23 3/5 - 35 1/2 - 47 1/4 inches RECESSED GRIP PROFILE BASES



**BASE SOTTOLAVELLO CON ANTA //
 UNDER-SINK BASE UNIT WITH DOOR**

COD 200910

Altezza // Height 720 mm - 28 3/9 in
 Profondità // Depth 700 mm - 27 1/2 in

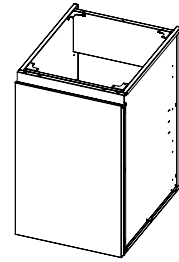

**BASE CON ANTA //
 BASE WITH DOOR**

COD 200923

Altezza // Height 720 mm - 28 3/9 in
 Profondità // Depth 700 mm - 27 1/2 in

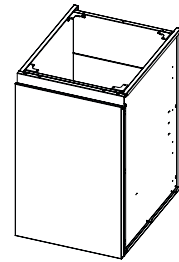

**BASE 2 CASSETTONI //
 BASE WITH 2 DEEP DRAWERS**

COD 200919

Altezza // Height 720 mm - 28 3/9 in
 Profondità // Depth 700 mm - 27 1/2 in
 Altezza Cassettone //
 Deep Drawers Height 357 mm - 14 in

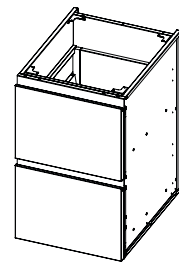

**BASE 1 CASSETTONE E 2 CASSETTI //
 BASE WITH A DEEP DRAWER AND 2 DRAWERS**

COD 200911

Altezza // Height 720 mm - 28 3/9 in
 Profondità // Depth 700 mm - 27 1/2 in
 Altezza Cassettone //
 Deep Drawers Height 357 mm - 14 in
 Altezza Cassetti //
 Drawers Height 177 mm - 7 in

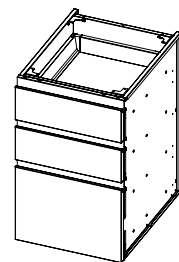

**BASE 4 CASSETTI //
 BASE WITH 4 DRAWERS**

COD 200915

Altezza // Height 720 mm - 28 3/9 in
 Profondità // Depth 700 mm - 27 1/2 in
 Altezza Cassetti //
 Drawers Height 177 mm - 7 in

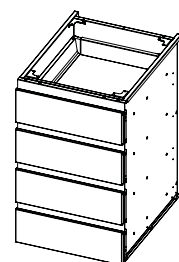



**BASE CON ANTA //
 BASE WITH DOOR**

COD 200503
 BASE SOTTOLAVELLO // UNDER-SINK BASE UNIT

Altezza // Height 720 mm - 28 3/9 in
 Profondità // Depth 700 mm - 27 1/2 in

COD 200924
 BASE UNIT // BASE

Altezza // Height 720 mm - 28 3/9 in
 Profondità // Depth 700 mm - 27 1/2 in

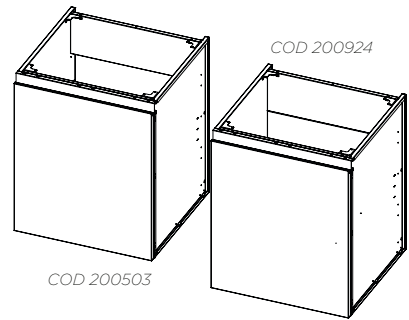

**BASE 2 CASSETTONI //
 BASE WITH 2 DEEP DRAWERS**

COD 200920

Altezza // Height 720 mm - 28 3/9 in
 Profondità // Depth 700 mm - 27 1/2 in
 Altezza Cassettone //
 Deep Drawers Height 357 mm - 14 in

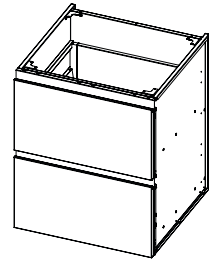

**BASE 1 CASSETTONE E 2 CASSETTI //
 BASE WITH A DEEP DRAWER AND 2 DRAWERS**

COD 200912

Altezza // Height 720 mm - 28 3/9 in
 Profondità // Depth 700 mm - 27 1/2 in
 Altezza Cassettone //
 Deep Drawers Height 357 mm - 14 in
 Altezza Cassetti //
 Drawers Height 177 mm - 7 in

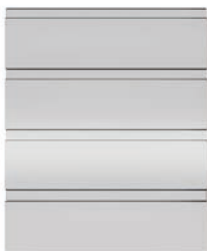
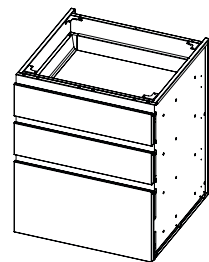

**BASE 4 CASSETTI //
 BASE WITH 4 DRAWERS**

COD 200916

Altezza // Height 720 mm - 28 3/9 in
 Profondità // Depth 700 mm - 27 1/2 in
 Altezza Cassetti //
 Drawers Height 177 mm - 7 in

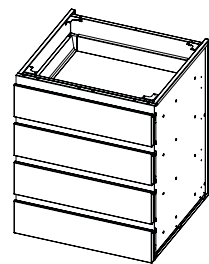

**BASE PER KAMADO //
 KAMADO BASE UNIT**

COD 201094

Altezza // Height 720 mm - 28 3/9 in
 Profondità // Depth 700 mm - 27 1/2 in

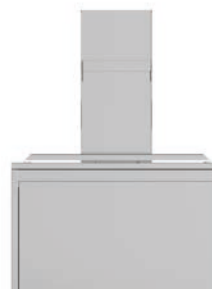

**BASE BASSA PER KAMADO //
 KAMADO LOW BASE UNIT**

COD 201268_SX

Altezza // Height 383 mm - 28 3/9 in
 Profondità // Depth 700 mm - 27 1/2 in



**BASE SOTTOLAVELLO CON ANTA //
 UNDER-SINK BASE UNIT WITH DOOR**

COD 200506

Altezza // Height 720 mm - 28 3/9 in
 Profondità // Depth 700 mm - 27 1/2 in

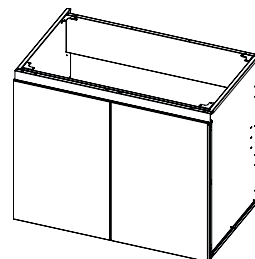

**BASE CON ANTA //
 BASE WITH DOOR**

COD 200925

Altezza // Height 720 mm - 28 3/9 in
 Profondità // Depth 700 mm - 27 1/2 in

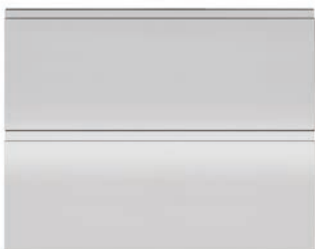
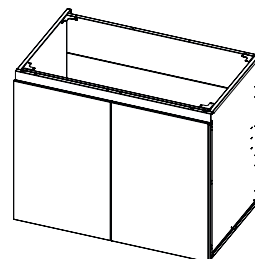

**BASE 2 CASSETTONI //
 BASE WITH 2 DEEP DRAWERS**

COD 200921

Altezza // Height 720 mm - 28 3/9 in
 Profondità // Depth 700 mm - 27 1/2 in
 Altezza Cassettone //
 Deep Drawers Height 357 mm - 14 in

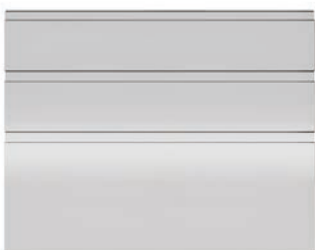
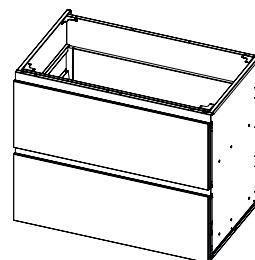

**BASE 1 CASSETTONE E 2 CASSETTI //
 BASE WITH A DEEP DRAWER AND 2 DRAWERS**

COD 200913

Altezza // Height 720 mm - 28 3/9 in
 Profondità // Depth 700 mm - 27 1/2 in
 Altezza Cassettone //
 Deep Drawers Height 357 mm - 14 in
 Altezza Cassetti //
 Drawers Height 177 mm - 7 in

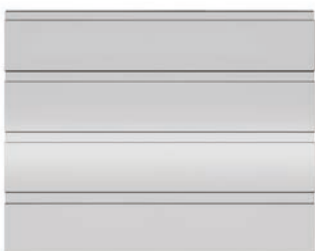
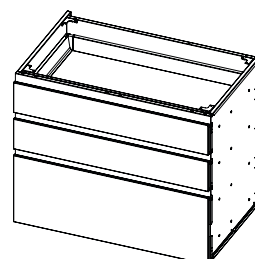

**BASE 4 CASSETTI //
 BASE WITH 4 DRAWERS**

COD 200917

Altezza // Height 720 mm - 28 3/9 in
 Profondità // Depth 700 mm - 27 1/2 in
 Altezza Cassetti //
 Drawers Height 177 mm - 7 in

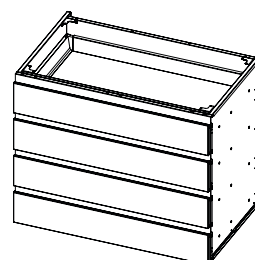



**BASE SOTTOLAVELLO CON ANTA //
 UNDER-SINK BASE UNIT WITH DOOR**

COD 200504

Altezza // Height 720 mm - 28 3/9 in
 Profondità // Depth 700 mm - 27 1/2 in

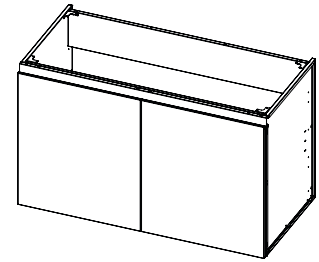

**BASE CON ANTA //
 BASE WITH DOOR**

COD 200926

Altezza // Height 720 mm - 28 3/9 in
 Profondità // Depth 700 mm - 27 1/2 in

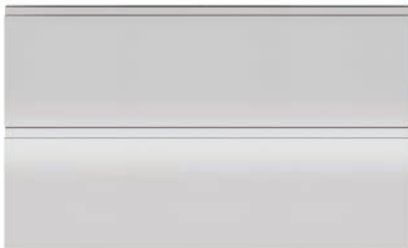
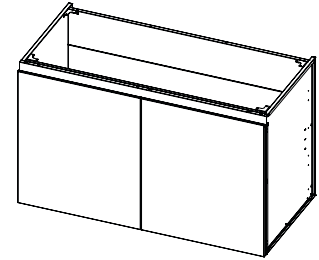

**BASE 2 CASSETTONI //
 BASE WITH 2 DEEP DRAWERS**

COD 200922

Altezza // Height 720 mm - 28 3/9 in
 Profondità // Depth 700 mm - 27 1/2 in
 Altezza Cassettone //
 Deep Drawers Height 357 mm - 14 in

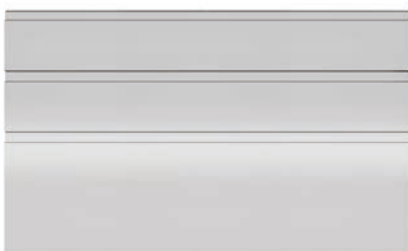
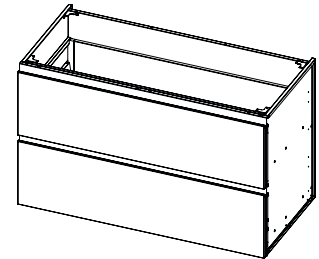

**BASE 1 CASSETTONE E 2 CASSETTI //
 BASE WITH A DEEP DRAWER AND 2 DRAWERS**

COD 200914

Altezza // Height 720 mm - 28 3/9 in
 Profondità // Depth 700 mm - 27 1/2 in
 Altezza Cassettone //
 Deep Drawers Height 357 mm - 14 in
 Altezza Cassetti //
 Drawers Height 177 mm - 7 in

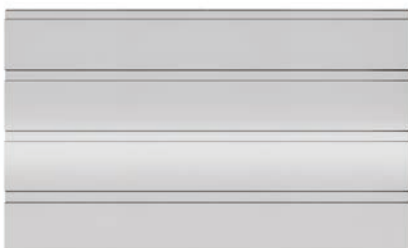
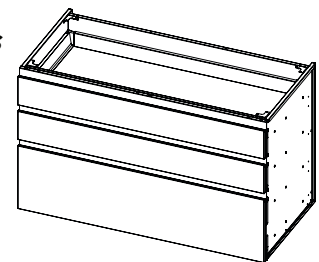

**BASE 4 CASSETTI //
 BASE WITH 4 DRAWERS**

COD 200918

Altezza // Height 720 mm - 28 3/9 in
 Profondità // Depth 700 mm - 27 1/2 in
 Altezza Cassetti //
 Drawers Height 177 mm - 7 in

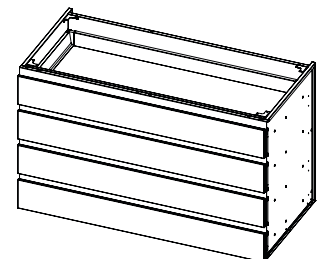

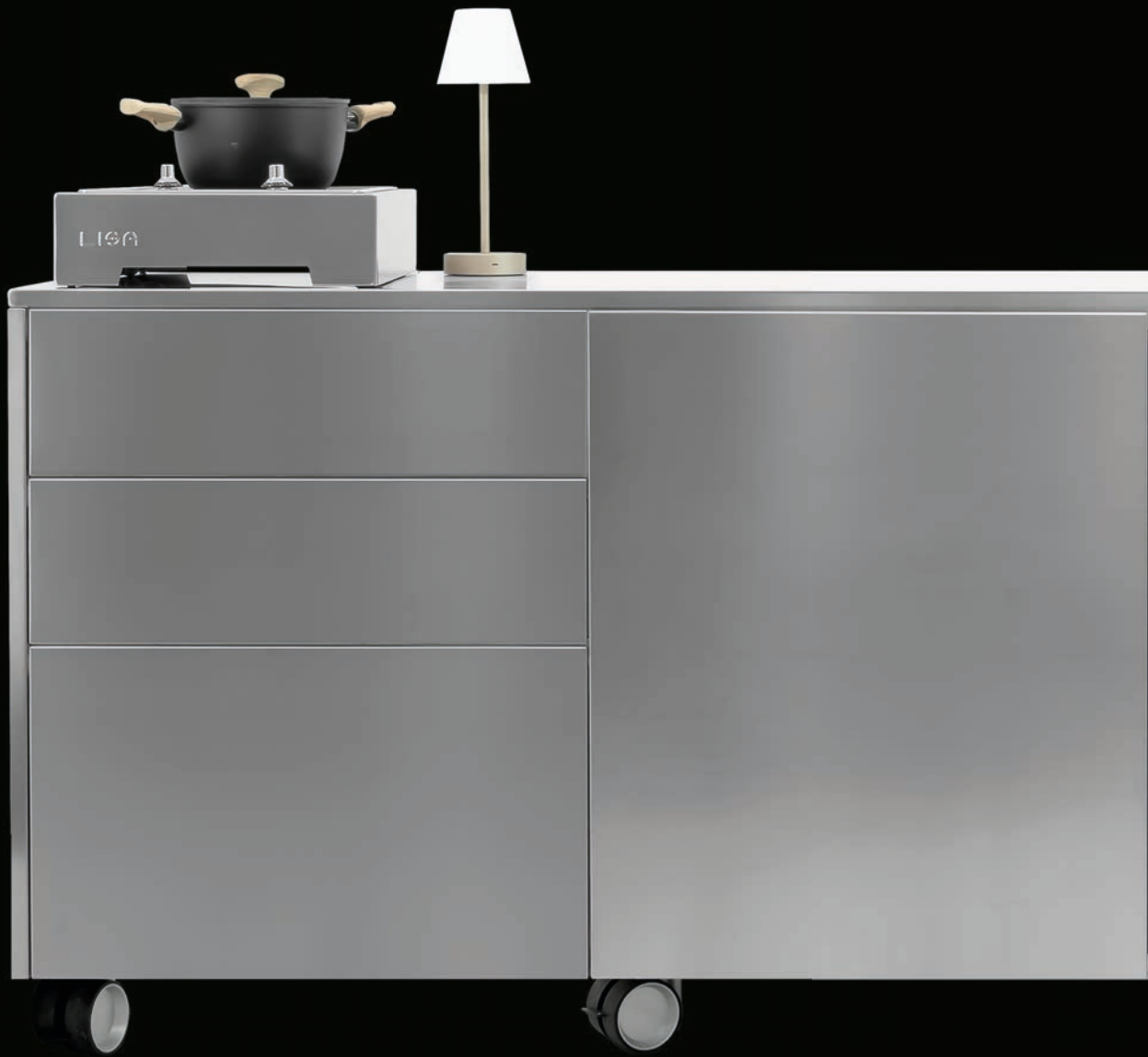

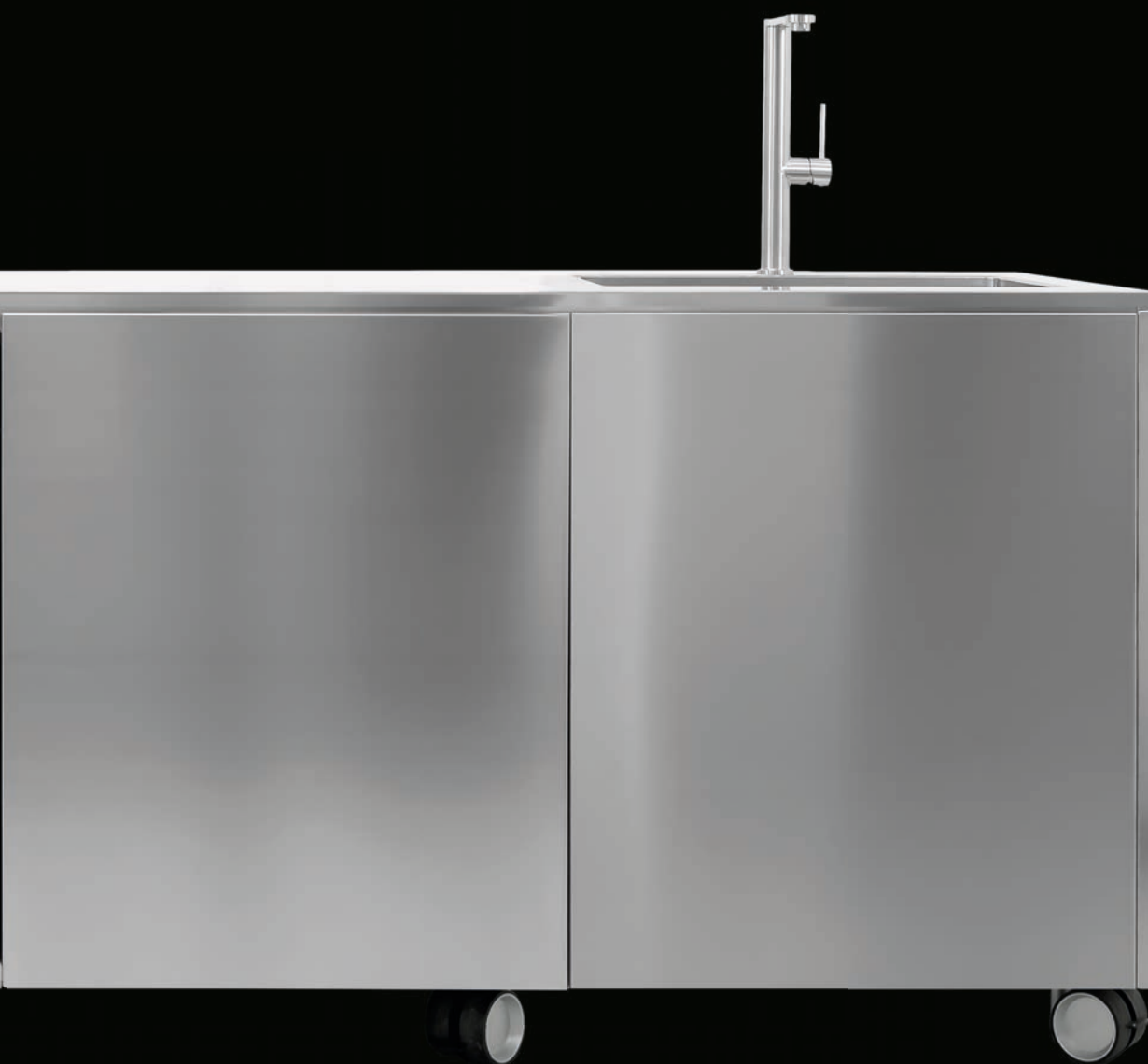

LINEA PANTELLERIA

BASI CON TIP-ON 45 - 60 - 90 - 120 cm

17 6/8 - 23 3/5 - 35 1/2 - 47 1/4 inches TIP-ON BASES



**BASE SOTTOLAVELLO CON ANTA //
 UNDER-SINK BASE UNIT WITH DOOR**

COD 200910

Altezza // Height 720 mm - 28 3/9 in
 Profondità // Depth 700 mm - 27 1/2 in

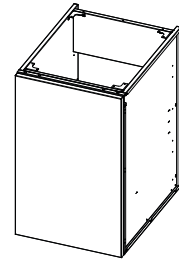

**BASE CON ANTA //
 BASE WITH DOOR**

COD 200923

Altezza // Height 720 mm - 28 3/9 in
 Profondità // Depth 700 mm - 27 1/2 in

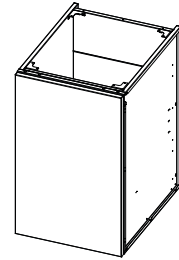

**BASE 2 CASSETTONI //
 BASE WITH 2 DEEP DRAWERS**

COD 200935

Altezza // Height 720 mm - 28 3/9 in
 Profondità // Depth 700 mm - 27 1/2 in
 Altezza Cassettone //
 Deep Drawers Height 357 mm - 14 in

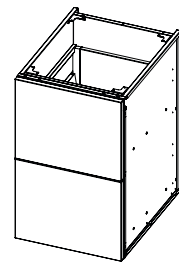

**BASE 1 CASSETTONE E 2 CASSETTI //
 BASE WITH A DEEP DRAWER AND 2 DRAWERS**

COD 200931

Altezza // Height 720 mm - 28 3/9 in
 Profondità // Depth 700 mm - 27 1/2 in
 Altezza Cassettone //
 Deep Drawers Height 357 mm - 14 in
 Altezza Cassetti //
 Drawers Height 177 mm - 7 in

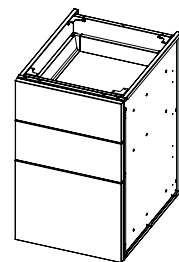

**BASE 4 CASSETTI //
 BASE WITH 4 DRAWERS**

COD 200927

Altezza // Height 720 mm - 28 3/9 in
 Profondità // Depth 700 mm - 27 1/2 in
 Altezza Cassetti //
 Drawers Height 177 mm - 7 in

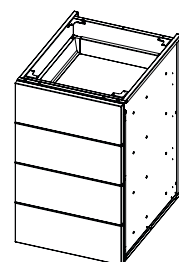



**BASE CON ANTA //
 BASE WITH DOOR**

COD 200503
BASE SOTTOLAVELLO // UNDER-SINK BASE UNIT

Altezza // Height 720 mm - 28 3/9 in
 Profondità // Depth 700 mm - 27 1/2 in

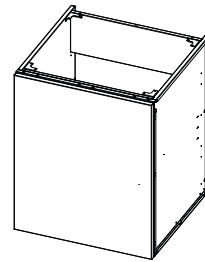

**BASE CON ANTA //
 BASE WITH DOOR**

COD 200924
BASE UNIT // BASE

Altezza // Height 720 mm - 28 3/9 in
 Profondità // Depth 700 mm - 27 1/2 in

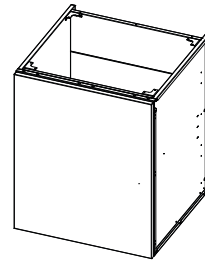

**BASE 2 CASSETTONI //
 BASE WITH 2 DEEP DRAWERS**

COD 200936

Altezza // Height 720 mm - 28 3/9 in
 Profondità // Depth 700 mm - 27 1/2 in
 Altezza Cassettone //
 Deep Drawers Height 357 mm - 14 in

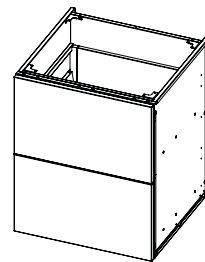

**BASE 1 CASSETTONE E 2 CASSETTI //
 BASE WITH A DEEP DRAWER AND 2 DRAWERS**

COD 200932

Altezza // Height 720 mm - 28 3/9 in
 Profondità // Depth 700 mm - 27 1/2 in
 Altezza Cassettone //
 Deep Drawers Height 357 mm - 14 in
 Altezza Cassetti //
 Drawers Height 177 mm - 7 in

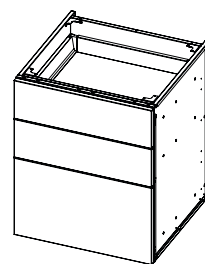

**BASE 4 CASSETTI //
 BASE WITH 4 DRAWERS**

COD 200928

Altezza // Height 720 mm - 28 3/9 in
 Profondità // Depth 700 mm - 27 1/2 in
 Altezza Cassetti //
 Drawers Height 177 mm - 7 in

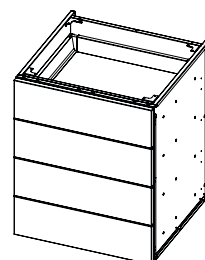



BASE SOTTOLAVELLO CON ANTA //
UNDER-SINK BASE UNIT WITH DOOR

COD 200506

Altezza // Height 720 mm - 28 3/9 in
 Profondità // Depth 700 mm - 27 1/2 in

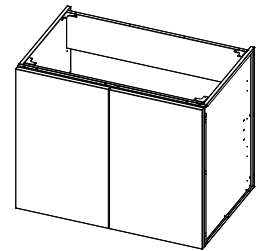

BASE CON ANTA //
BASE WITH DOOR

COD 200925

Altezza // Height 720 mm - 28 3/9 in
 Profondità // Depth 700 mm - 27 1/2 in

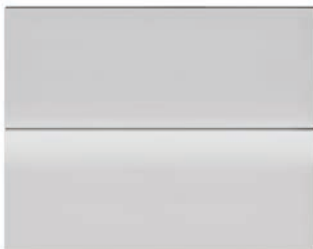
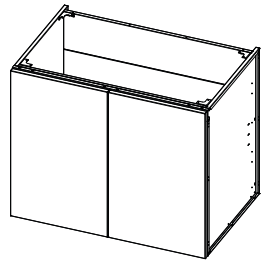

BASE 2 CASSETTONI //
BASE WITH 2 DEEP DRAWERS

COD 200937

Altezza // Height 720 mm - 28 3/9 in
 Profondità // Depth 700 mm - 27 1/2 in
 Altezza Cassettone //
 Deep Drawers Height 357 mm - 14 in

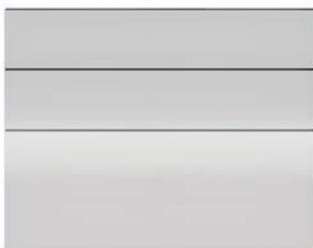
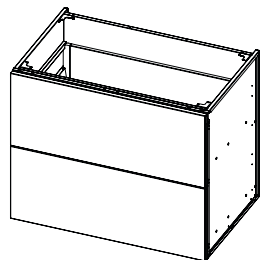

BASE 1 CASSETTONE E 2 CASSETTI //
BASE WITH A DEEP DRAWER AND 2 DRAWERS

COD 200933

Altezza // Height 720 mm - 28 3/9 in
 Profondità // Depth 700 mm - 27 1/2 in
 Altezza Cassettone //
 Deep Drawers Height 357 mm - 14 in
 Altezza Cassetti //
 Drawers Height 177 mm - 7 in

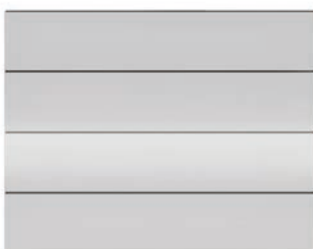
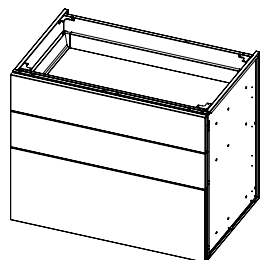

BASE 4 CASSETTI //
BASE WITH 4 DRAWERS

COD 200929

Altezza // Height 720 mm - 28 3/9 in
 Profondità // Depth 700 mm - 27 1/2 in
 Altezza Cassetti //
 Drawers Height 177 mm - 7 in

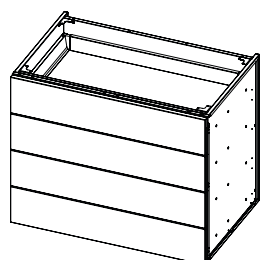



BASE SOTTOLAVELLO CON ANTA //
UNDER-SINK BASE UNIT WITH DOOR

COD 200504

Altezza // Height 720 mm - 28 3/9 in
 Profondità // Depth 700 mm - 27 1/2 in

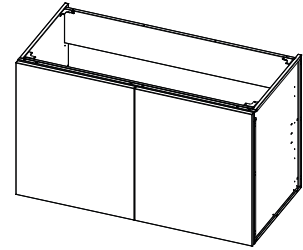

BASE CON ANTA //
BASE WITH DOOR

COD 200926

Altezza // Height 720 mm - 28 3/9 in
 Profondità // Depth 700 mm - 27 1/2 in

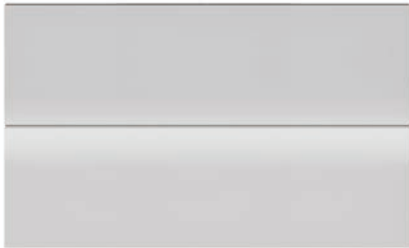
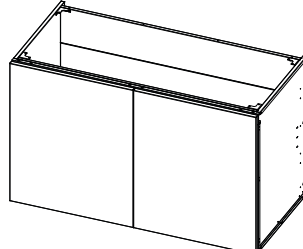

BASE 2 CASSETTONI //
BASE WITH 2 DEEP DRAWERS

COD 200938

Altezza // Height 720 mm - 28 3/9 in
 Profondità // Depth 700 mm - 27 1/2 in
 Altezza Cassettone //
 Deep Drawers Height 357 mm - 14 in

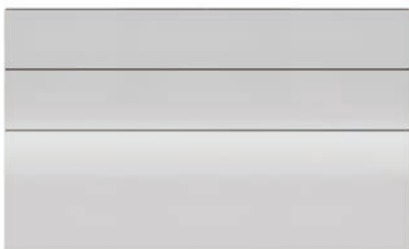
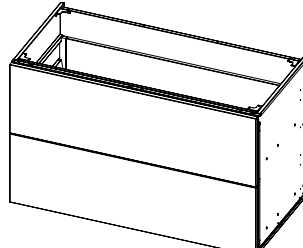

BASE 1 CASSETTONE E 2 CASSETTI //
BASE WITH A DEEP DRAWER AND 2 DRAWERS

COD 200934

Altezza // Height 720 mm - 28 3/9 in
 Profondità // Depth 700 mm - 27 1/2 in
 Altezza Cassettone //
 Deep Drawers Height 357 mm - 14 in
 Altezza Cassetti //
 Drawers Height 177 mm - 7 in

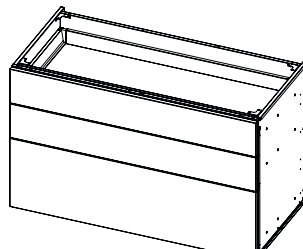

BASE 4 CASSETTI //
BASE WITH 4 DRAWERS

COD 200930

Altezza // Height 720 mm - 28 3/9 in
 Profondità // Depth 700 mm - 27 1/2 in
 Altezza Cassetti //
 Drawers Height 177 mm - 7 in

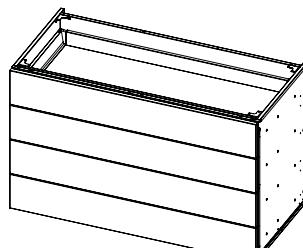





LINEA LIBERTY

BASI CON GOLA 45 - 60 - 90 - 100 - 120 cm

17 6/8 - 23 3/5 - 35 1/2 - 39 3/8 - 47 1/4 inches RECESSED GRIP PROFILE BASES



BASE LIBERTY CON CASSETTO E SPORTELLINO 45CM // LIBERTY BASE WITH A DRAWER AND A DOOR 17 6/8in

COD 201239_45

Altezza // Height	720 mm - 28 3/9 in
Profondità // Depth	700 mm - 27 1/2 in
Altezza Sportello // Door Height	443 mm - 14 in
Altezza Cassetto // Drawer Height	243 mm - 7 in

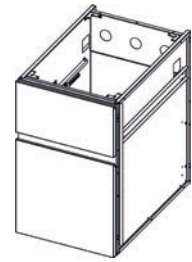

BASE LIBERTY CON SPORTELLINO PER BOMBOLA GAS 45 CM // LIBERTY BASE WITH A DOOR FOR GAS CYLINDER 17 6/8in

COD 201292

Altezza // Height	720 mm - 28 3/9 in
Profondità // Depth	700 mm - 27 1/2 in

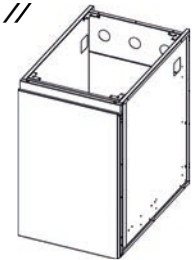

BASE LIBERTY CON CASSETTO E SPORTELLINO 60CM // LIBERTY BASE WITH A DRAWER AND A DOOR 23 3/5in

COD 201239_60

Altezza // Height	720 mm - 28 3/9 in
Profondità // Depth	700 mm - 27 1/2 in
Altezza Sportello // Door Height	443 mm - 14 in
Altezza Cassetto // Drawer Height	243 mm - 7 in

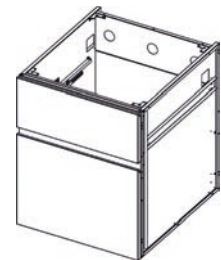

BASE LIBERTY SOTTOLAVELLO 60CM // UNDER-SINK LIBERTY BASE 23 3/5in

COD 201290_60

Altezza // Height	720 mm - 28 3/9 in
Profondità // Depth	700 mm - 27 1/2 in
Altezza Sportello // Deep Drawers Height	443 mm - 14 in

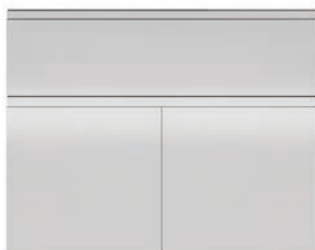
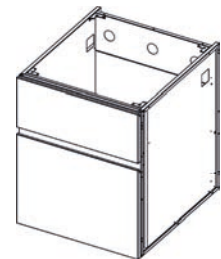

BASE LIBERTY CON CASSETTO E SPORTELLI 90CM // LIBERTY BASE WITH A DRAWER AND DOORS 35 2/5in

COD 201239_90

Altezza // Height	720 mm - 28 3/9 in
Profondità // Depth	700 mm - 27 1/2 in
Altezza Sportelli // Doors Height	443 mm - 14 in
Altezza Cassetto // Drawers Height	243 mm - 7 in

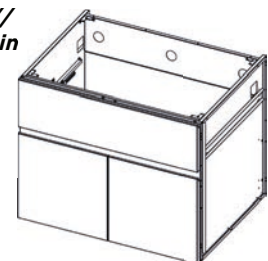

MODULO DA INCASSO CON SPORTELLI 90 - 100 - 120 CM //
SLIDE-IN MODULE WITH DOORS 35 1/2 - 39 3/8 - 47 1/4 in

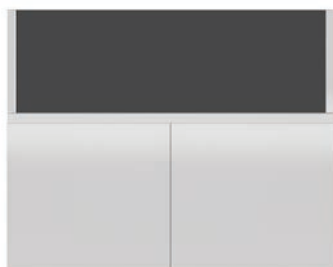

COD 201240_90
 COD 201240_100
 COD 201240_120

Altezza // Height 720 mm - 28 3/9 in
 Profondità // Depth 700 mm - 27 1/2 in
 Altezza Sportelli // Doors Height 443 mm - 14 in

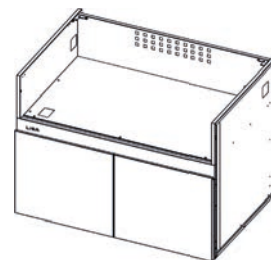

MODULO DA INCASSO CON CASSETTONE 90 - 100 - 120 CM //
SLIDE-IN MODULE WITH A DEEP DRAWER 35 1/2 - 39 3/8 - 47 1/4 in

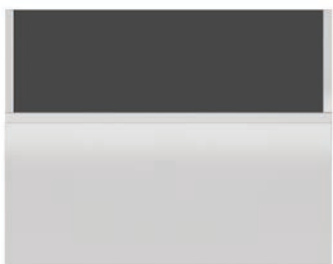

COD 201299_90
 COD 201299_100
 COD 201299_120

Altezza // Height 720 mm - 28 3/9 in
 Profondità // Depth 700 mm - 27 1/2 in
 Altezza Cassettone // Deep Drawer Height 243 mm - 7 in

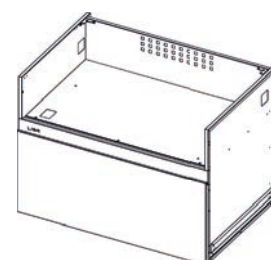

Modulo 90 cm compatibile con Napoleon BI32 - BILD485 - BIPRO500 //
 Module 35 1/2 in compatible with Napoleon BI32 - BILD485 - BIPRO500

Modulo 100 cm compatibile con Napoleon BIG38 - BILEX605 //
 Module 39 3/8 in compatible with Napoleon BIG38 - BILEX605

Modulo 120 cm compatibile con Napoleon BIG44 //
 Module 47 1/4 in compatible with Napoleon BIG44

KIT DI COMPENSAZIONE PER BARBECUE A GAS //
TAILOR MADE KIT COMPATIBLE WITH GAS BARBECUE

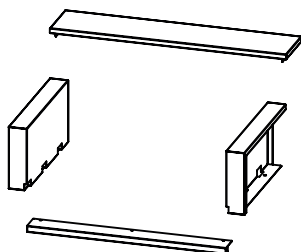

KIT BI32	COD OUT020_BI32
KIT BIG38	COD OUT020_BIG38
KIT BIG44	COD OUT020_BIG44
KIT BILD485	COD OUT020_BILD485
KIT BILEX605	COD OUT020_BILEX605
KIT BIPRO500	COD OUT020_BIPRO500

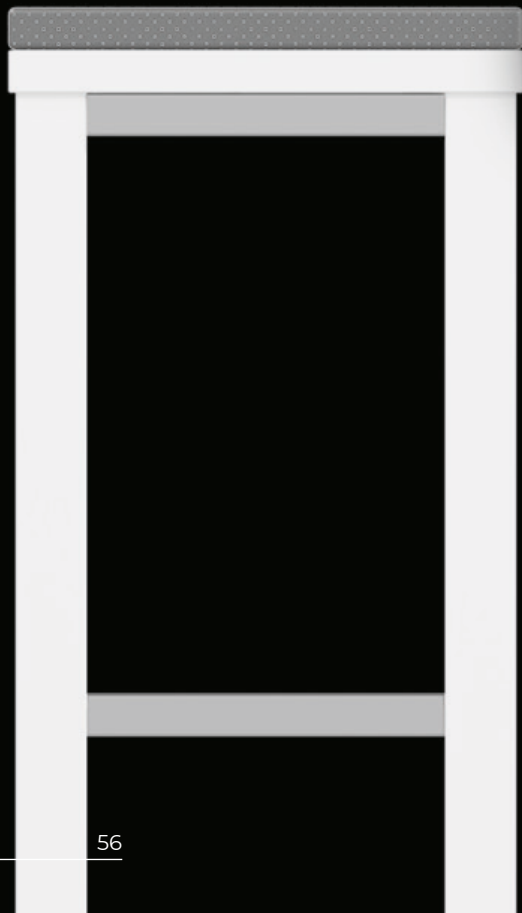

ACCESSORI // ACCESSORIES

Rendi la cucina unica in ogni particolare

Make the kitchen unique in every detail





LAVELLO APELL 70 cm //
APELL 70 cm SINK

COD LNR74FSFR

Lavello Apell in acciaio inox 304 scotch brite sopra top di 70 cm di larghezza interna e raggio 10 mm.

Apell 304 scotch brite stainless steel 27 1/2 in internal sink above worktop with width and 2/5 in radius.

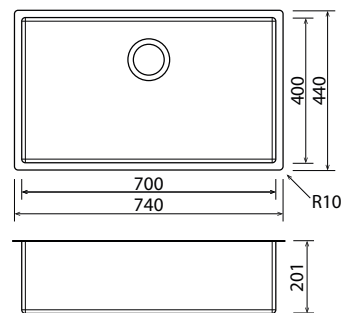

LAVELLO APELL 50 cm //
APELL 50 cm SINK

COD LNR54FSFR

Lavello Apell in acciaio inox 304 scotch brite sopra top di 50 cm di larghezza interna e raggio 10 mm.

Apell 304 scotch brite stainless steel 19 6/9 in internal sink above worktop with width and 2/5 in radius.

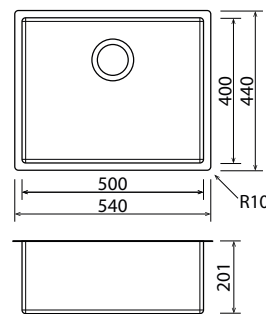

LAVELLO APELL 34 cm //
APELL 34 cm SINK

COD LNR38FSFR

Lavello Apell in acciaio inox 304 scotch brite sopra top di 34cm di larghezza interna e raggio 10mm.

Apell 304 scotch brite stainless steel 13 2/5 in internal sink above worktop with width and 2/5 in radius.

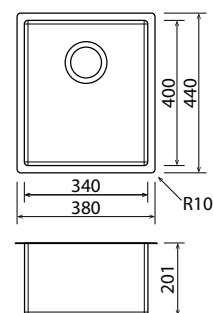

MISCELATORE APELL //
APELL MIXER TAP

COD AP6040SS

Miscelatore monocomando Apell in acciaio inox. Altezza 30,6 cm dal top. Erogatore di 21,8 cm di profondità.

Apell single-lever mixer tap in stainless steel. Height 12 in from top. Depth 8 3/5 in.

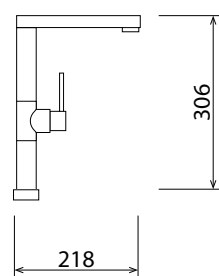

MISCELATORE ABBATTIBILE LISA //
LISA HIDDEN MIXER TAP

COD MM00000334

Miscelatore abbattibile della Lisa con monocomando in acciaio inox.

Lisa hidden mixer tap with single-lever in stainless steel.

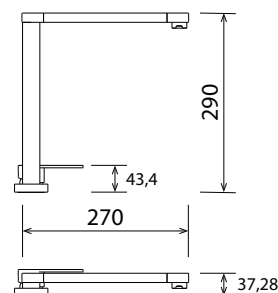



**MISCELATORE ABBATTIBILE LISA CON DOCCETTA
ACCIAIO INOX // LISA HIDDEN MIXER TAP**

COD MM00000424

Miscelatore monocomando per lavello a canna tonda a scomparsa e doccetta estraibile. Flessibili di alimentazione F 3/8".

*Single-lever mixer tap collapsible spout and pull-out hand shower.
3/8" female connection hoses.*

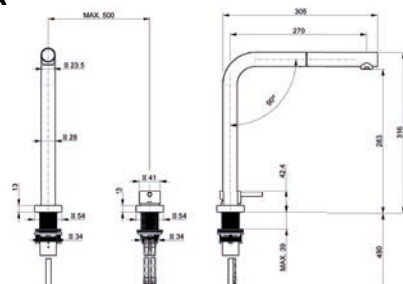

**MISCELATORE ABBATTIBILE LISA CON DOCCETTA
NERO GALVANICO // LISA HIDDEN MIXER TAP**

COD MM00000425

Miscelatore monocomando per lavello a canna tonda a scomparsa e doccetta estraibile. Flessibili di alimentazione F 3/8".

*Single-lever mixer tap collapsible spout and pull-out hand shower.
3/8" female connection hoses.*

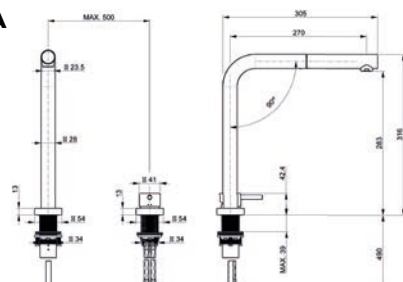

BARBECUE A GAS ATTUALMENTE COMPATIBILI CON CUCINA LIBERTY //
GAS BARBECUE CURRENTLY COMPATIBLE WITH LIBERTY KITCHENS



BI32



BIG38



BIG44



BILD485



BILEX605



BIPRO500

FINITURE // FINISHES



ACCIAIO //
BRUSHED STAINLESS STEEL

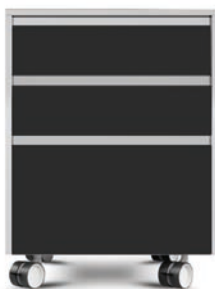

ANTRACITE //
ANTHRACITE RAL 9004

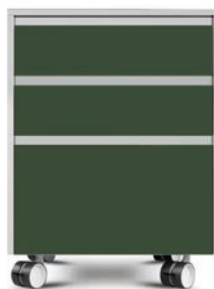

VERDE //
GREEN RAL 6003



BIANCO //
WHITE RAL 9001



**PIANI COTTURA STAND ALONE //
STAND ALONE APPLIANCES**

COD OUT010IS

COD OUT010IF

COD OUT010TS

COD OUT010BS

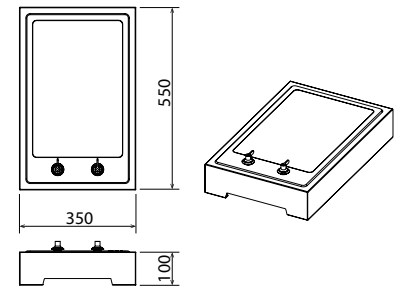

Stand alone con possibilità d'incasso di piani cottura domino.

Smeg countertop induction cooker. Free-standing. Satin-finish stainless steel colour. Pot size detection and adjustment system.

MULTIFLEX



COD MM00000426

Tecnologia a induzione di ultima generazione. Due controlli touch slider con accesso diretto a 15 livelli. Display di potenza LED dinamico.

MISURE // MEASUREMENTS: 40 x 52 x 5 cm

Latest generation of induction technology. Two Slider Touch Controls with direct access to 15 levels. Dynamic LED power display.

TEPPANYAKI 380



COD MM00000427

Tecnologia a induzione di ultima generazione. Funzione stop & go con due aree della piastra indipendenti controllate termostaticamente.

MISURE // MEASUREMENTS: 38 x 52 x 6 cm

Latest generation of induction technology. Stop & go function with two independent thermostatically controlled griddle areas.

TEPPANYAKI 580



COD MM00000428

Tecnologia a induzione di ultima generazione. Funzione stop & go. La funzione bridge consente di accoppiare entrambe le zone. Controllo touch slider con accesso diretto a ciascuno dei 10 livelli di riscaldamento.

MISURE // MEASUREMENTS: 58 x 52 x 6 cm

Latest generation of induction technology. Stop & go function. Bridge function allows to couple both zones. Slider touch control with direct access to each of 10 heating levels.



RUOTA CON FRENO // WHEEL WITH BRAKE

COD MM00000259

RUOTA SENZA FRENO // WHEEL WITHOUT BRAKE

COD MM00000258

Ruota piroettante in alluminio con gomma nera. Portata 80Kg.

Aluminium swivel castor with black rubber. Load capacity 80 kg

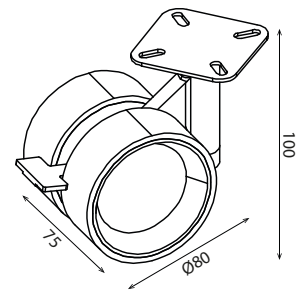

PIEDE FISSO IN ACCIAIO // FIXED STEEL FOOT

COD 201141 (h 100mm)

COD 201141_150 (h 150mm)

Piedino con piastra in acciaio inox, alto 100 mm, regolabile in altezza di 15mm. Portata 40Kg.

Foot with stainless steel plate, 4 in high, height adjustable by 3/5 in. Load capacity 40 kg

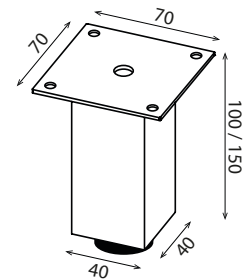

SGABELLO // STOOL

COD OUT009B

Sgabello in ferro verniciato bianco con poggia piedi e supporti in acciaio inox.

A white painted iron stool with stainless steel footrest and supports.

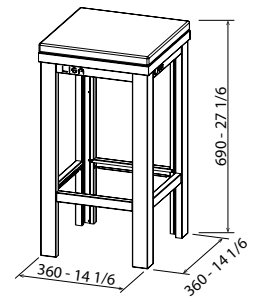

TOP IN GRES 2 cm // 4/5in GRES TOPS



MARMO ORO // GOLD MARBLE



BIANCO CEMENTO // CEMENT WHITE



NERO VENATO // BLACK VEINED

TOP HPL 1.2 cm // 2/4in HPL TOPS

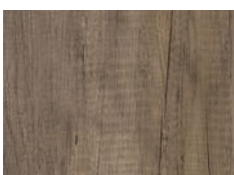

QUERCIA CUORE NERO // OAK (BLACK HEART)

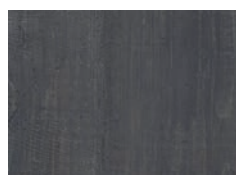

CARBONE TAVOLATO // BURNED WOOD



LAVAGNA CUORE NERO // BLACKBOARD (BLACK HEART)

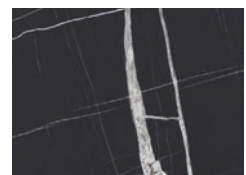

NERO STREET CUORE NERO // BLACK STREET (BLACK HEART)

—

—



Showroom in

Via Po, 57
66020 San Giovanni Teatino (CH)
+39 085 430 8333



lisaoutdoor.com

